

Analysis on utilizing the linear optimization method for improving micro grids energy efficiency and voltage frequency stabilization

¹Yohan Dondapati, ²Dr.R.Sankar, ³R Ajeet Kumar, ⁴Sunkara Venkatesh

^{1, 3}Assistant Professor, ²Professor ⁴Student, Dept. of Electrical & Electronics Engineering, Newton's Institute of Engineering, Macherla, Andhra Pradesh, India.

Abstract

Grid-connected the usage of demand response services and the active participation of producers in the energy market are made possible by micro grids, which are essential to the bottom-up modernization of the electric distribution network and the development of next-generation Smart Grids. Energy storage is necessary to combat the intermittent nature of resource power output, enhance power quality, and increase the controllability of power flow. Due to their ability to increase the system's voltage/frequency stability and energy efficiency by coordinating energy storage systems with the generating units, these systems are becoming more and more common in micro grids.

Keywords: Micro grid, energy storage system, state of charge, linear optimization.

INTRODUCTION

The issues of energy and sustainability are without a doubt the central problems of the twenty-first century. One-way power flow systems have been developed with centralized power generation, radial long-distance transmission, distribution, and power consumption requirements. The current energy infrastructure has operated essentially in the same way for almost a century. It is based on centralized power generation, which primarily uses fossil fuels and nuclear energy, and is distributed to users via a vast distribution network. In order to fully realize the advantages of offering optimal integration of renewable sources, cost savings from energy, and increased grid dependability and resiliency, the idea of micro grids and their technology have advanced through time. Shortages of fossil fuels, rising greenhouse gas emissions, and more frequent power outages have prompted increased efforts to design new electric power system concepts that will enable a more sustainable and environmentally friendly operation. A micro grid's generation can be classed as dispatchable or non-dispatchable. Internal combustion engine (ICE) generators, batteries, super capacitors, and flywheels are examples of dispatchable or controllable energy generators. Due to the unpredictability of the sun and wind, most renewable energy sources such as wind and PV are non-dispatchable. A microgrid's generation can be classed as dispatchable or non-dispatchable. Internal combustion engine (ICE) generators, batteries, super capacitors, and flywheels are examples of dispatchable or controllable energy generators. Due to the unpredictability of the sun and wind, most renewable energy sources such as wind and PV are non-dispatchable. To meet load demands, power electronics inverters are used as the interface between DGs and microgrids. The importance and sensitivity of the loads in the microgrid should be prioritized. When power is insufficient for all loads during a blackout or programmed islanding operation of a microgrid, load shedding or a scheduled time-shift is required for the operation of non-critical loads in order to balance supply and demand. The emergence of new technology, as well as advances in business models and policies, are transforming the distribution system into a more complex and interconnected network of systems at numerous levels. As a result, the entire system resembles a jumble of smarter grids that connect hardware, software, and communication technologies.

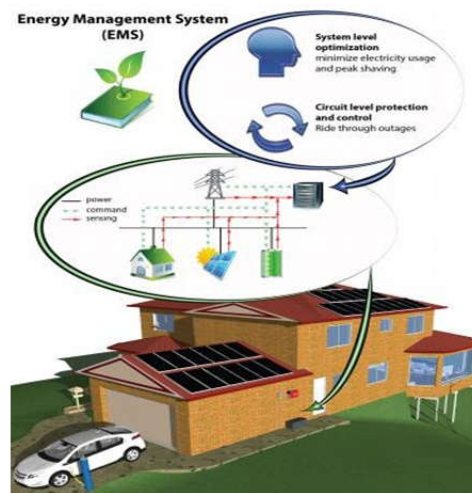

Fig. 1. Typical microgrid with EMS system

Massive adoption of renewable energy generation is a must in efforts to decrease our carbon footprint. Renewable energy sources like solar and wind, on the other hand, are intermittent and cannot provide a consistent supply of electricity. Indeed, one of the main objections used by sceptics of solar and wind energy is the lack of reliability. By providing a mechanism for storing energy when it is produced and distributing it to customers when it is needed, energy storage capacity added to the electric grid can help ease some of these problems. Many of the concerns listed above can be addressed using electric microgrids with an energy management system. Microgrids use physical closeness to connect distributed generation, distributed energy resources, energy storages, and loads for ease of control, power sharing, and management. They give electricity and other forms of energy to consumers for their advantage. The energy management system (EMS) is a microgrid's central control unit, which regulates power flow between microgrid elements as well as between the microgrid and the external grid. It ensures the microgrid's steady and safe operation, as well as protection against unexpected power outages and potential faults, at the circuit level protection and control. Figure 1 shows the typical microgrid with EMS.

DESIGN AND MODELING

Heuristic algorithms are ideal for energy management systems (1: N) = energy since they reduce the amount of time it takes to make a decision. This method is based on the following principle: at each time interval, avoid wasting the available renewable potential. Model predictive control is used to prevent output power reductions caused by converter failure, panel shading, and dirt collection on PV panels. The EMS's goal is to reduce the amount of energy drawn from the grid. The balance equation is expressed as

$$P_{load}(t) \square P_{PV}(t) \square P_{Grid}(t) \square P_{Battery}(t)$$

stored in battery. The designed model consists of microgrid, variable load, static load, PV, and battery storage system. Model is simulated with assumption that weather is clear and the initial battery storage is 50%. Comparative analysis of the designed model for energy management with traditional distribution method and linear optimization is carried out.

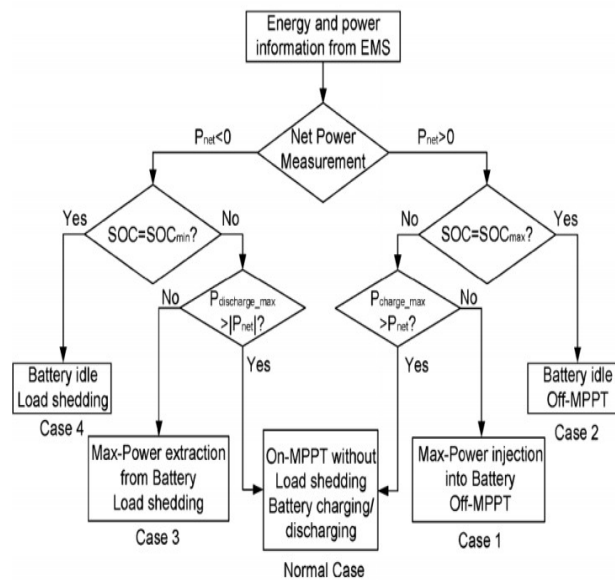

Fig. 2. Optimization of microgrid with EMS system.

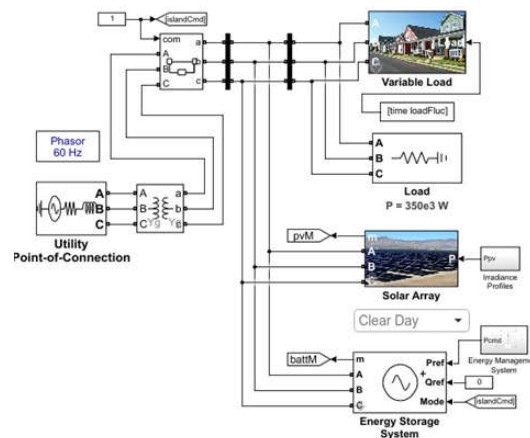

Fig. 3. Typical microgrid with EMS system

power generated by PV, provided by the ESS and power grid, demands from the load, respectively. The minimization problem is formulated using the above balance equation.

A probabilistic model with a modified scenario-based decision-making mechanism is used to achieve optimal day-ahead scheduling of electrical and thermal energy resources. When uncertainties are modeled in operational planning problems, the expected outcomes become more realistic. Implementing an intelligent energy management system based on near-accurate generating power interpretation reduces operating costs significantly. Figure 2 shows the schematics of the algorithm used for the optimization of energy management of the microgrid the conventional microgrid system. The designed Simulink model consists of micro grid having solar energy harvesting system, battery storage unit, variable and static load connected to the grid.

Linear program optimization is carried out for the energy management and loss control given as

RESULTS AND DISCUSSION

Time domain analysis of the designed energy management system for microgrid employing linear optimization technique is carried out. Two set of simulations were done; one with traditional technique and linear optimization technique. Figure

4 shows the power in kW for (photo voltaic) PV, energystorage system (ESS), grid, and load.

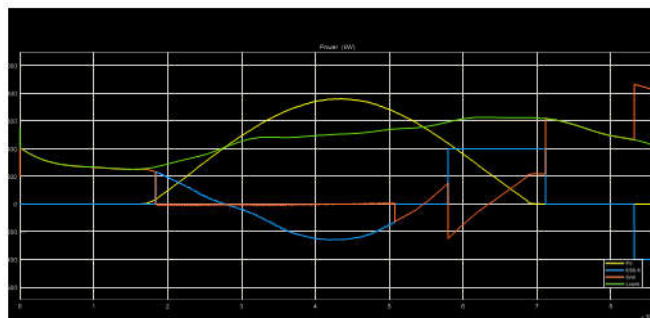

Fig. 4. Power in kW of PV, ESS, grid, and load

Figure 5 shows the energy storage system charging response throughout 24 hrs cycle. Since the PV panel can charge the ESS during daytime when the load is minimum. Taking the initial 50% state of charge (SoC), making impossible to provide power. Figure 6 shows the microgrid cost usage using traditional method.

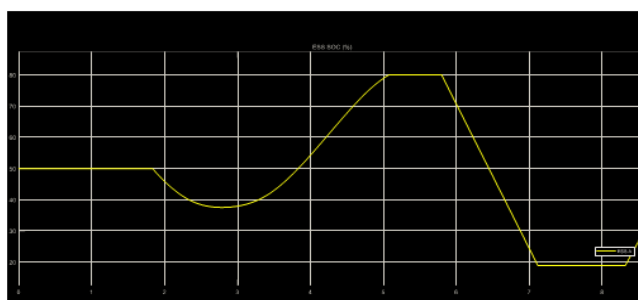

Fig. 5. ESS state of charge

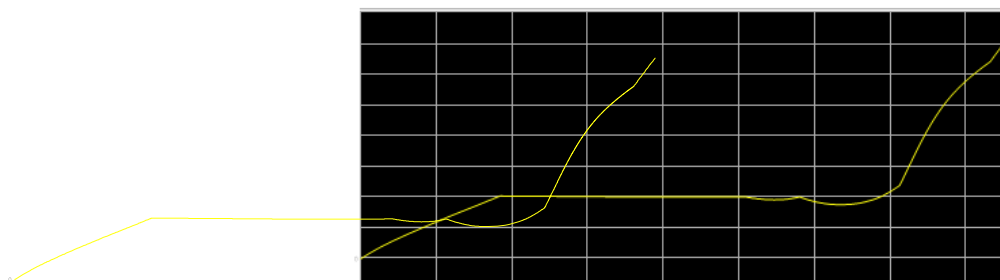

Fig. 6. Cost of microgrid usage.

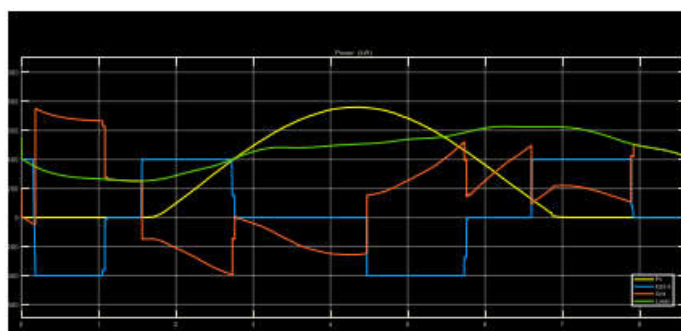

Fig. 7. Power in kW of PV, ESS, grid, and load using optimized method.

In order to improve the energy management system of the microgrid, linear optimization method used shows better results as compared to traditional method. Figure 7 shows the power of PV, microgrid system, ESS, and load in kW. It can be observed that the storage system encounters for the grid power during the power demand. Figure 8 shows the ESS Soc with optimized method, it can be observed that the ESS perfectly responds to the charging in the non-utilization time and delivers power at high demand. Figure 9 shows the usage cost of microgrid using linear optimized method which is higher as compared to the traditional

method.

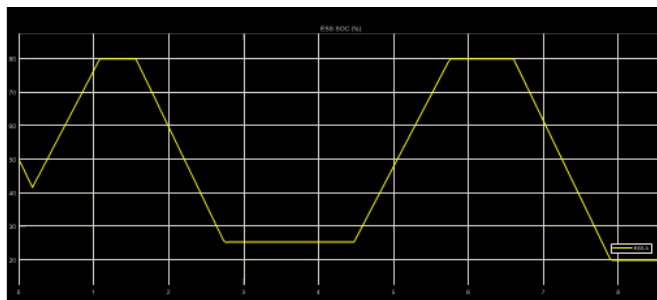

Fig. 8. ESS Soc with optimized method

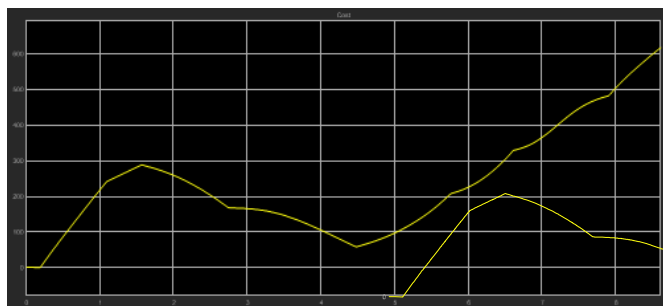

Fig. 9. Microgrid usage cost with optimized method

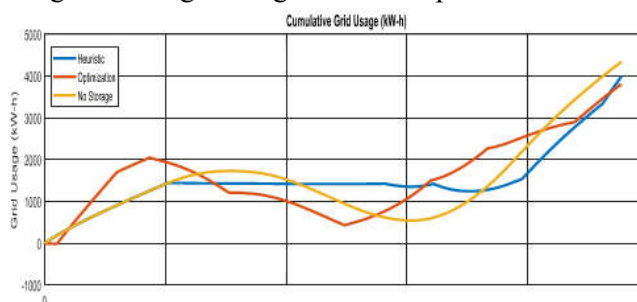

Figure 10 shows the comparison of cumulative grid usage without optimized method, with linear optimization, and usagewithout energy storage system. It is evident from the graph that even at lower power demand hours; the grid usage in traditional method is higher as compared with optimized method.

CONCLUSION

In order to efficiently balance the energy consumption of consumers, we compared traditional (heuristic) and linear optimization methods for energy storage and distribution from microgrid. The microgrid is a networked energy storage system with changeable load. Utilizing energy buffering in storage systems and reducing grid demand are the goals of optimization. The findings clearly show that the linear optimization strategy decreases grid utilization. Future research can be done to examine the impact of the ESS's state of charge and the weather on the energy produced by a PV system.

REFERENCES

[1] S. F. Bush, S. Goel, and G. Simard, IEEE Vision for Smart Grid Communications: 2030 and Beyond Roadmap, IEEE Std., 2013.
 [2] M. F. Zia, E. Elbouchikhi, and M. Benbouzid, “Microgrids energy management systems: A critical review on methods, solutions, and prospects,” Applied Energy, vol. 222, p. 1033–1055, May 2018.
 [3] Z. Liu, Y. Chen, R. Zhuo, and H. Jia, “Energy storage capacity optimization for autonomy microgrid considering chp and ev scheduling,” Applied Energy, vol. 210, p. 1113–1125, 2018.
 [4] Q. Wang, J. Zeng, Z. Wang, and J. Liu, “Distributed game-theoretic interactive algorithm for microgrid

- optimization,” Jul. 2018.
- [5] T. Logenthiran, R. T. Naayagi, W. L. Woo, V.-T. Phan, and K. Abidi, “Intelligent control system for microgrids using multiagent system,” *IEEE Trans. Emerg. Sel. Topics Power Electron.*, vol. 3, pp. 1036–1045, 2015.
- [6] T. Zhao, F. H. Choo, L. Zhang, Y. Gu, and P. Wang, “Game theory based distributed energy trading for microgrids parks,” Oct. 2017.
- [7] J. Chen and R. Fu, “Environmental/economic dispatch approach for microgrid with uncooperative game control strategy,” Nov. 2018.
- [8] O. Carbonell-Nicolau and R. P. McLean, “Refinements of nash equilibrium in potential games,” *Theoretical Economics*, vol. 9, pp. 555–582, 2014.
- [9] S. Ramos, M. Silva, F. Fernandes, and Z. Valea, “Modelling real solar cell using pscad/matlab,” Nov. 2012.
- [10] S. Ramos, J. Soares, T. Pinto, and Z. Vale, “Short-term wind forecasting to support virtual power player operation,” 2013.
- [11] B. Canizes, M. Silva, P. Faria, S. Ramos, and Z. Vale, “Resource scheduling in residential microgrids considering energy selling to external players,” 2015.
- [12] P. Yang, G. Tang, and A. Nehorai, “A game-theoretic approach for optimal time-of-use electricity pricing,” *EE Trans. Power Syst*, vol. 28, pp. 884–892, May 2013.
- [13] G. W. Arnold, «Challenges and opportunities in smart grid: a position article» *Proceedings of the IEEE*, vol. 99, no. 6, pp. 922–927, 2011.
- [14] W. Tong, "A New Control Method for Inverters Parallel Operation in Microgrid," 2016 3rd International Conference on Information Science and Control Engineering (ICISCE), Beijing, 2016, pp. 769-773.
- [15] A. Khaledian and M. A. Golkar, "A new power sharing control method for stability enhancement of islanding microgrids," 2016 IEEE 16th International Conference on Environment and Electrical Engineering (EEEIC), Florence, 2016, pp. 1-5.
- [16] R. Heydari, T. Dragicevic and F. Blaabjerg, "Coordinated Operation of VSCs Controlled by MPC and Cascaded Linear Controllers in Power Electronic Based AC Microgrid," 2018 IEEE 19th Workshop on Control and Modeling for Power Electronics (COMPEL), Padua, 2018, pp. 1-4.
- [17] Hongyu He, Bei Han, Guojie Li, Keyou Wang and Shaojie Liu, "A novel control method based on consensus algorithm for microgrids," 2017 IEEE 3rd International Future Energy Electronics Conference and ECCE Asia (IFEEC 2017 - ECCE Asia), Kaohsiung, 2017, pp. 2203- 2207.
- [18] [6] C. Block, D. Neumann, C. Weinhardt «A Market Mechanism for Energy Allocation in Micro-CHP Grids» *Proceedings of the 41st Hawaii International Conference on System Sciences – 2008*, pp. 1-11.
- [19] [7] J. Pascual, J. Barricarte, P. Sanchis, L. Marroyo «Energy management strategy for a renewable-based residential microgrid with generation and demand forecasting», *Applied Energy* 158 (2015) 12–25.
- [20] [8] V. K. Kanakesh, B. Sen, J. Soni and S. K. Panda, "Control strategies for Electric Spring in an islanded microgrid: A comparative evaluation," 2017 IEEE 3rd International Future Energy Electronics Conference and ECCE Asia (IFEEC 2017 - ECCE Asia), Kaohsiung, 2017, pp. 1714- 1718.
- [21] [9] J. Dong, F. Gao, X. Guan, Q. Zhai and J. Wu, "Storage-Reserve Sizing With Qualified Reliability for Connected High Renewable Penetration Micro-Grid," in *IEEE Transactions on Sustainable Energy*, vol. 7, no. 2, pp. 732-743, April 2016.
- [22] [10] A. Ouammi, H. Dagdougui and R. Sacile, "Optimal Control of Power Flows and Energy Local Storages in a Network of Microgrids Modeled as a System of Systems," in *IEEE Transactions on Control Systems Technology*, vol. 23, no. 1, pp. 128-138, Jan. 2015.
- [23] [11] Z. Xu, X. Han, P. Wang, W. Qin and H. Zhang, "Two-level energy management system for coordination control of microgrid," 2015 IEEE International Conference on Information and Automation, Lijiang, 2015, pp. 153-157.